

Installation Instructions

B SYSTEM

Thank you for ordering Excalibur shelving. We assure you of a functional, durable shelving system which will serve you for years to come.

Tools Required

- Tape Measure
- Straight blade screwdriver
or 1/4" nut driver
- Hammer

Receiving Instructions

Check parts against packing list.

Inspect shipment for any damage caused during transit. Note damaged goods on bill of lading from shipping company.

Report this damage to the delivering carrier to process the claim for replacement parts.

P. O. Box 498 - 28 Riverside Drive
Contoocook, NH 03229
(603)746-6200 - FAX (603)746-4165

1 Find bottom of upright.

Bottom of upright has spreader 1 1/2" above bottom of post.

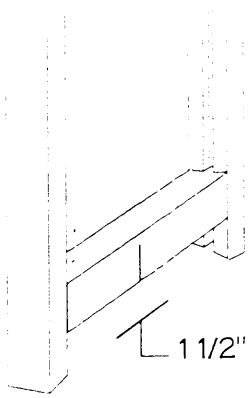

2 Set two uprights face down on floor.

Bottom of uprights

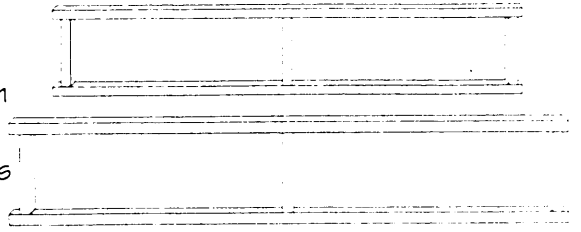

4 Measure from corner to corner. Adjust until both measurements are equal.

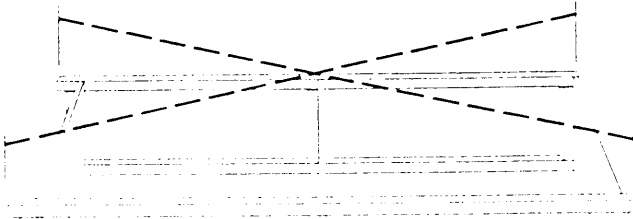

3 Set shelves above each spreader.

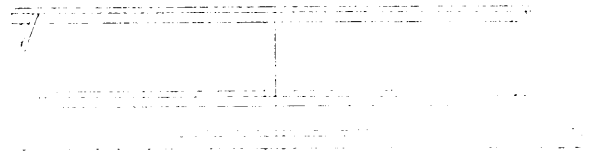

5 Attach x-brace with screws

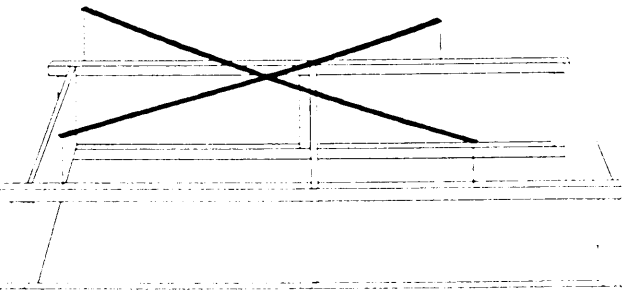

OR....

6 Center back panel on uprights. Attach with nails or screws every 12" or so.

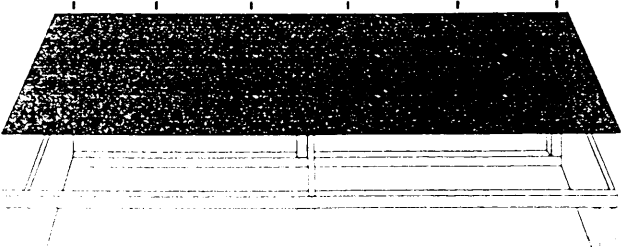

7 Stand unit. This completes a basic unit.

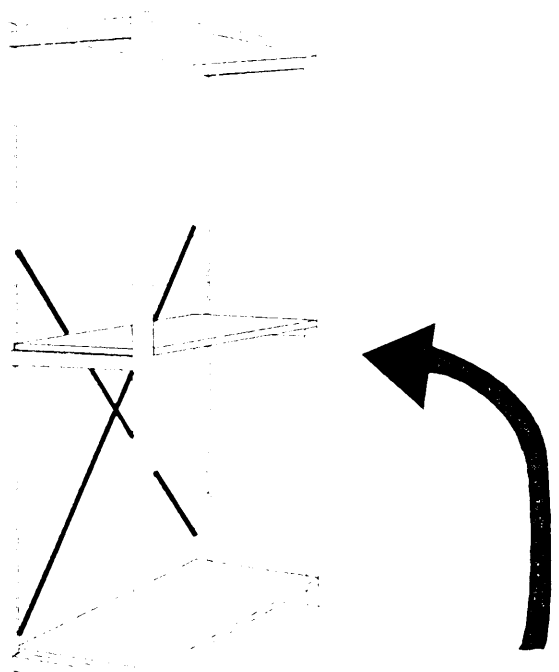

8 Build add-on unit. Add another upright and set shelves above each spreader.

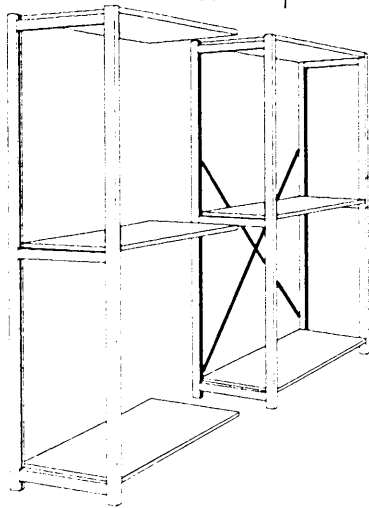

Alternate basic and add-on units as shown.

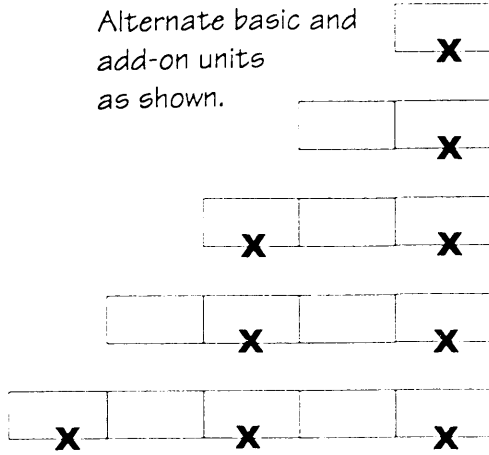

9 Clamp back to back units together

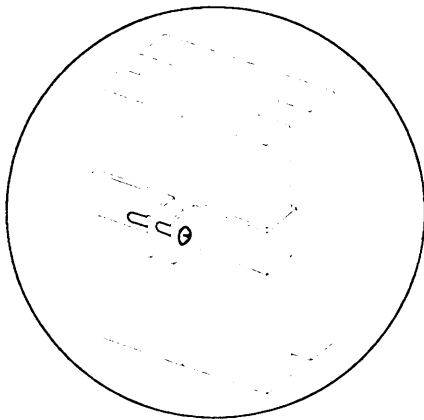

Place clamp beneath top and middle spreaders

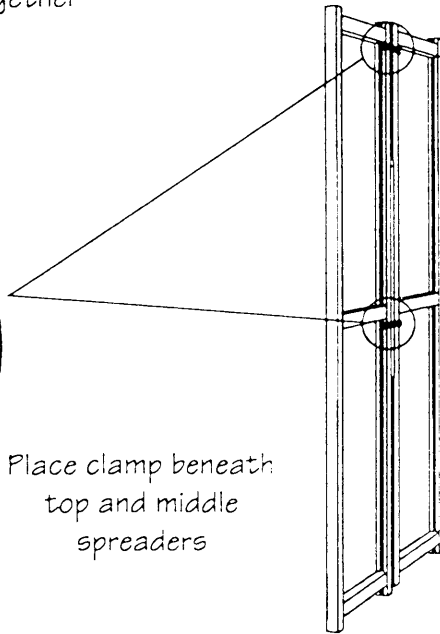

10 Install Individual Kickplates

Slide kickplate onto wires.

Nail kickplate wires into sides of uprights with hammer.

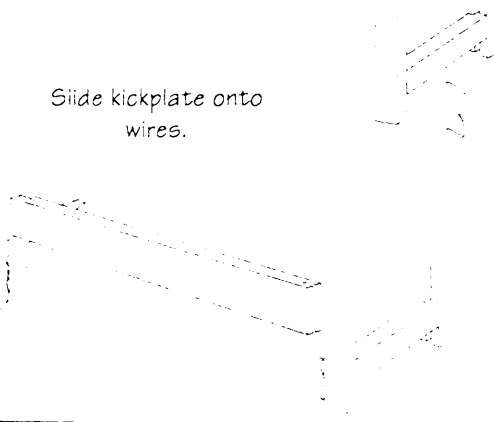

11 Set Shelves

Place four shelf pins in holes at desired location.

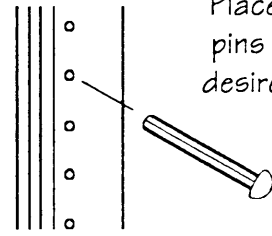

Set shelf on front pins and lay onto rear pins

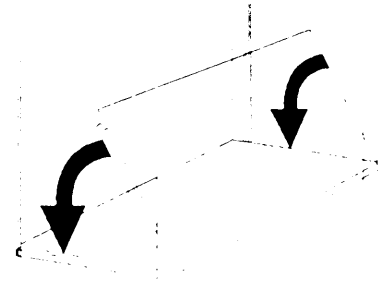

12 Set Hangrods

Place four shelf pins in holes at desired location.

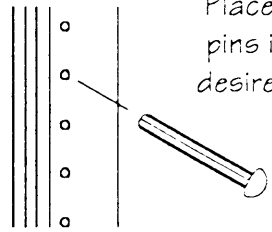

Set rails on front pins and lay onto rear pins

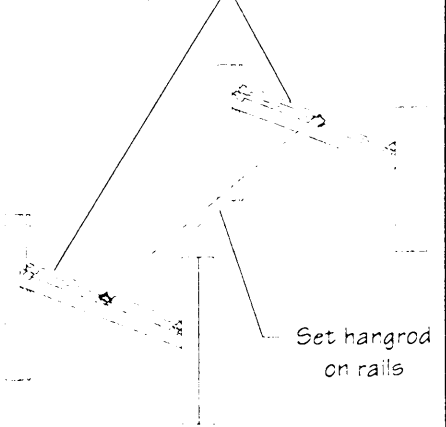

13

Continuous Wood Kickplate

Cut random lengths of 1x4 to fit overall length of run. Attach to face of uprights with finish nails.

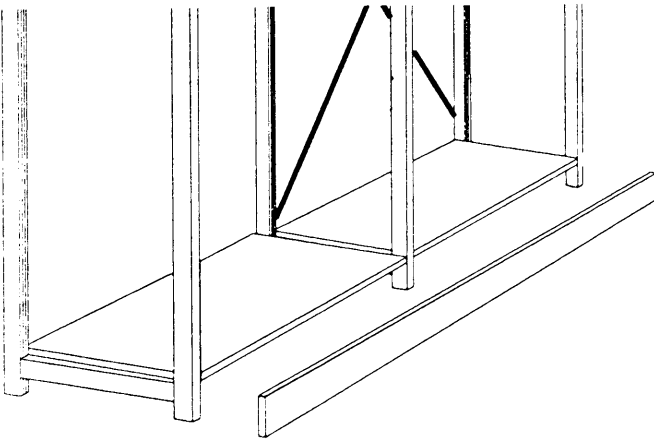

14

Floor Anchor

Position angle below upright and screw to face of upright. Anchor plate to floor with masonry screws or anchors.

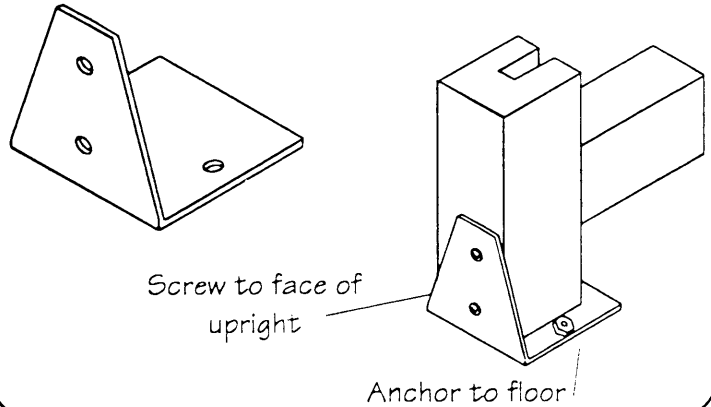

15

Wall Attachment

(Ordered separately)

Attach 1 x 4 to tops of upright with appropriate hardware

Overhead Bracing

(Ordered separately)

16

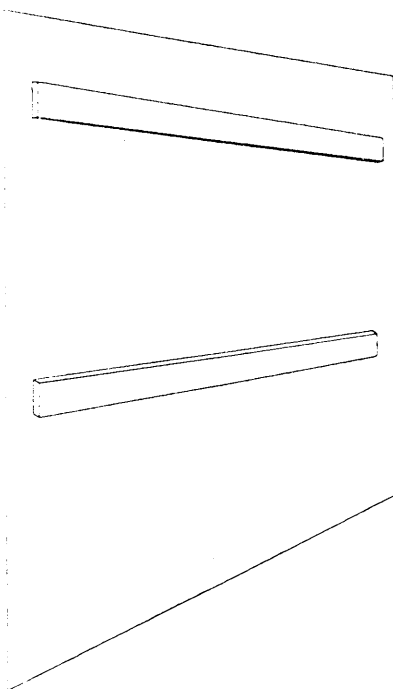

Attach 1x4 strips to wall at top and center of units. Attach to wall or studs with appropriate hardware.

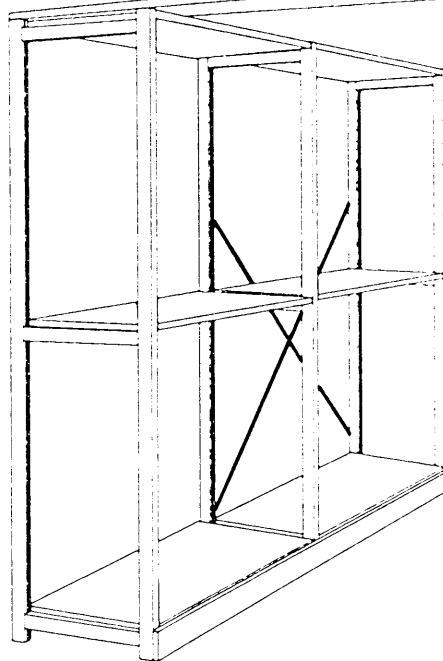

Attach units to 1x4 strips through uprights. Pre-drill holes in upright groove before attachment.

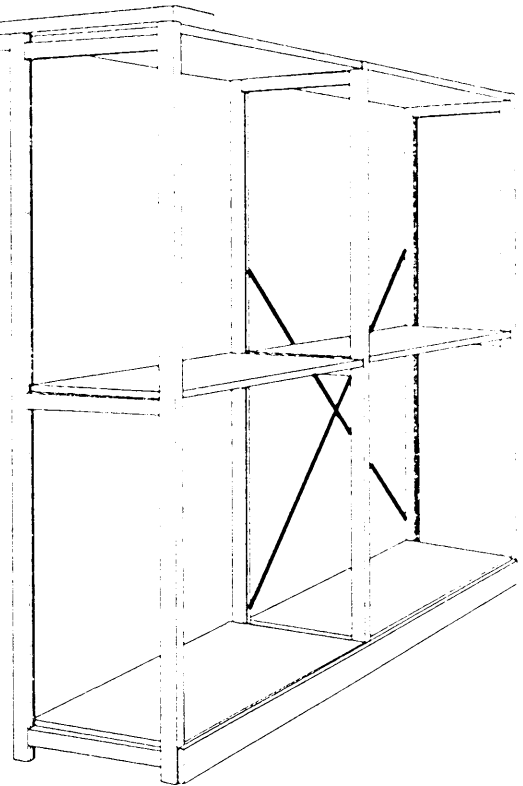

If you experience any kind of problem with the components of your shelving or with the installation ... or if you would like to order additional shelving, call your sales representative or our customer service department at (603)746-6200.

Free-Standing Brace Kit Assembly

1 Find bottom of upright

Bottom of upright has spreader 1 1/2" above bottom of upright

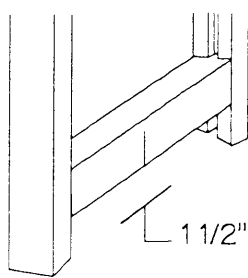

2 Identify parts



End bolt



Center bolt



Brace nut

Top brace



Bottom brace

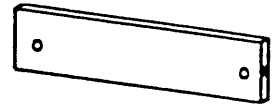

3 Construct End Upright

- Insert nuts into one end of each brace
- Bolt braces to upright with end bolts.

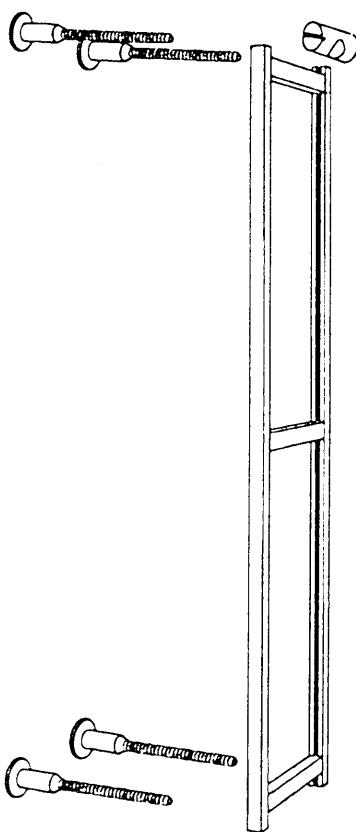

4 Construct Center Upright

- Insert nuts into one end of each brace
- Screw center bolts into braces until tight
- Slide upright onto center bolts
- Insert nuts into one end of next set of braces
- Turn braces onto center bolts until tight

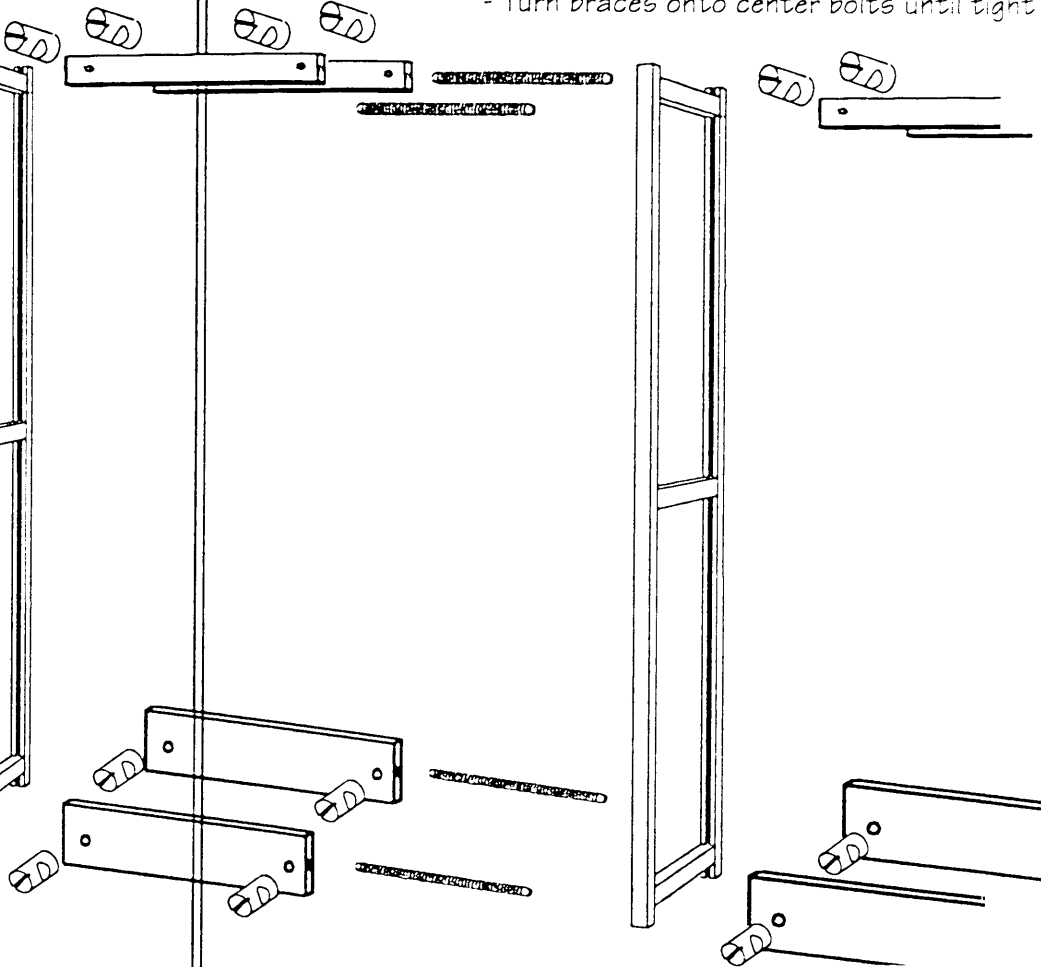

bottom of uprights

If you experience any kind of problem with the components of your shelving or with the installation ... or if you would like to order additional shelving, call your sales representative or our customer service department at (603)746-6200.